

HIGH ENVIRONMENTAL RESISTANCE

TURQUOISE SWITCHES ABS TYPE

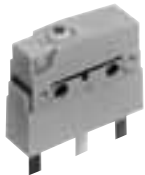
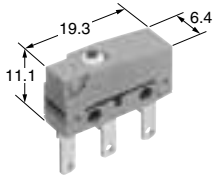

FEATURES

- Subminiature size (19.8×11.1×6.4 mm)
- Sealed construction for use in adverse environment-Sealed construction by epoxy resin and rubber cap greatly reduces possible miscontact due to contaminants such as dust. Conforming to IP67* of IEC protective construction classification
- Elastomer double molding technology, an industry first and ultrasonic swaging technology contribute to uniform sealing in high production quantities
- Expansion of low-level circuit type
- We offer a Au clad 2-ply contact type (for small loads) that we developed specifically for small current and voltage loads in the range of 1 mA to 100 mA and 5 V to 30 V.
- UL/CSA/VDE/SEMKO approved (AS for Au-clad twin layer, VDE and SEMKO are not approved.)

* Based on the protective construction classification of IEC, items which satisfy the test requirements are denoted with an IP designation.

TYPICAL APPLICATIONS

- Automotive
- Home appliances (vacuum cleaner, air purifier)
- Others (gas cooking range)

<http://panasonic-denko.co.jp/ac/e/service/environment>

ORDERING INFORMATION

Ex. ABS 1 1 1 0 4 0 3

Type of switch	Wire and terminal position	Terminal	Contact arrangement	Actuator	Operating force by pin plunger (max.)	Contact*	Agency standard
ABS: Turquoise switch S type	1: Straight type 4: Right angle 5: Left angle	1: .110 quick-connect terminal 4: Solder terminal 5: PC board terminal 6: Wire leads	1: SPDT 2: SPST-NC 3: SPST-NO	0: Pin plunger 1: Short hinge lever 2: Hinge lever 3: Long hinge lever 4: Simulated roller lever 6: Roller lever 8: Leaf lever	4: 0.98 N 5: 1.47 N	0: AgNi alloy 1: Au-clad triple layer 4: Au-clad double layer	3: UL/CSA/VDE/SEMKO (AgNi alloy contact, Au-clad triple layer type) 9: UL/CSA (Au-clad double layer type)

Remarks: 1. Standard packing: Dust protected type 100 pcs./carton, 1,000 pcs./case; Immersion protected type 50 pcs./case.

2. SPST-NC and SPST-NO are only available for wire leads type.
3. Leaf lever is only available for wire leads type
4. As for wire position:

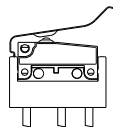

Straight type

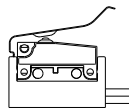

Wire opposite to the actuator side type (Right angle)

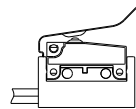

Wire actuator side type (Left angle)

5. Not every combination is available. Please refer to the following table, "PRODUCT TYPES".

* Contact

0: AgNi alloy



1: Au-clad triple layer

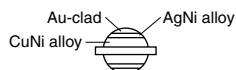

4: Au-clad double layer

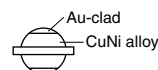

CONTACT ARRANGEMENT

1. SPDT

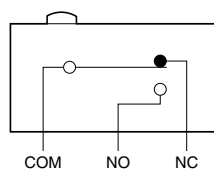

2. SPST-NC (Wire leads type only)

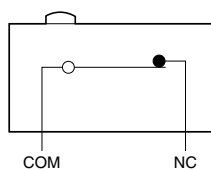

3. SPST-NO (Wire leads type only)

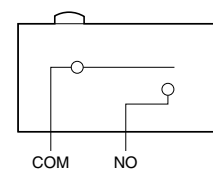
**PRODUCT TYPES****1. Dust protected type**

AgNi alloy

Actuator	Operating force Max.	.110 quick-connect terminal	Solder terminal	PC board terminal		
				Straight	Right angle	Left angle
Pin plunger	0.98 N	ABS1110403	ABS1410403	ABS1510403	ABS4510403	ABS5510403
	1.47 N	ABS1110503	ABS1410503	ABS1510503	ABS4510503	ABS5510503
Short hinge lever	0.39 N	ABS1111403	ABS1411403	ABS1511403	ABS4511403	ABS5511403
	0.59 N	ABS1111503	ABS1411503	ABS1511503	ABS4511503	ABS5511503
Hinge lever	0.34 N	ABS1112403	ABS1412403	ABS1512403	ABS4512403	ABS5512403
	0.54 N	ABS1112503	ABS1412503	ABS1512503	ABS4512503	ABS5512503
Long hinge lever	0.25 N	ABS1113403	ABS1413403	ABS1513403	ABS4513403	ABS5513403
	0.44 N	ABS1113503	ABS1413503	ABS1513503	ABS4513503	ABS5513503
Simulated roller lever	0.34 N	ABS1114403	ABS1414403	ABS1514403	ABS4514403	ABS5514403
	0.54 N	ABS1114503	ABS1414503	ABS1514503	ABS4514503	ABS5514503
Roller lever	0.39 N	ABS1116403	ABS1416403	ABS1516403	ABS4516403	ABS5516403
	0.59 N	ABS1116503	ABS1416503	ABS1516503	ABS4516503	ABS5516503

Au-clad triple layer

Actuator	Operating force Max.	.110 quick-connect terminal	Solder terminal	PC board terminal		
				Straight	Right angle	Left angle
Pin plunger	0.98 N	ABS1110413	ABS1410413	ABS1510413	ABS4510413	ABS5510413
	1.47 N	ABS1110513	ABS1410513	ABS1510513	ABS4510513	ABS5510513
Short hinge lever	0.39 N	ABS1111413	ABS1411413	ABS1511413	ABS4511413	ABS5511413
	0.59 N	ABS1111513	ABS1411513	ABS1511513	ABS4511513	ABS5511513
Hinge lever	0.34 N	ABS1112413	ABS1412413	ABS1512413	ABS4512413	ABS5512413
	0.54 N	ABS1112513	ABS1412513	ABS1512513	ABS4512513	ABS5512513
Long hinge lever	0.25 N	ABS1113413	ABS1413413	ABS1513413	ABS4513413	ABS5513413
	0.44 N	ABS1113513	ABS1413513	ABS1513513	ABS4513513	ABS5513513
Simulated roller lever	0.34 N	ABS1114413	ABS1414413	ABS1514413	ABS4514413	ABS5514413
	0.54 N	ABS1114513	ABS1414513	ABS1514513	ABS4514513	ABS5514513
Roller lever	0.39 N	ABS1116413	ABS1416413	ABS1516413	ABS4516413	ABS5516413
	0.59 N	ABS1116513	ABS1416513	ABS1516513	ABS4516513	ABS5516513

Au-clad double layer

Actuator	Operating force Max.	.110 quick-connect terminal	Solder terminal	PC board terminal		
				Straight	Right angle	Left angle
Pin plunger	0.98 N	ABS1110449	ABS1410449	ABS1510449	ABS4510449	ABS5510449
	1.47 N	ABS1110549	ABS1410549	ABS1510549	ABS4510549	ABS5510549
Short hinge lever	0.39 N	ABS1111449	ABS1411449	ABS1511449	ABS4511449	ABS5511449
	0.59 N	ABS1111549	ABS1411549	ABS1511549	ABS4511549	ABS5511549
Hinge lever	0.34 N	ABS1112449	ABS1412449	ABS1512449	ABS4512449	ABS5512449
	0.54 N	ABS1112549	ABS1412549	ABS1512549	ABS4512549	ABS5512549
Long hinge lever	0.25 N	ABS1113449	ABS1413449	ABS1513449	ABS4513449	ABS5513449
	0.44 N	ABS1113549	ABS1413549	ABS1513549	ABS4513549	ABS5513549
Simulated roller lever	0.34 N	ABS1114449	ABS1414449	ABS1514449	ABS4514449	ABS5514449
	0.54 N	ABS1114549	ABS1414549	ABS1514549	ABS4514549	ABS5514549
Roller lever	0.39 N	ABS1116449	ABS1416449	ABS1516449	ABS4516449	ABS5516449
	0.59 N	ABS1116549	ABS1416549	ABS1516549	ABS4516549	ABS5516549

* Agency standard: Please refer to "Ordering information".

ABS1,4,5

2. Immersion protected type (3 wire leads type SPDT)

AgNi alloy

Actuator	Operating force Max.	SPDT		
		Straight	Wire position Right angle	Left angle
Pin plunger	0.98 N	ABS1610403	ABS4610403	ABS5610403
	1.47 N	ABS1610503	ABS4610503	ABS5610503
Short hinge lever	0.39 N	ABS1611403	ABS4611403	ABS5611403
	0.59 N	ABS1611503	ABS4611503	ABS5611503
Hinge lever	0.34 N	ABS1612403	ABS4612403	ABS5612403
	0.54 N	ABS1612503	ABS4612503	ABS5612503
Long hinge lever	0.25 N	ABS1613403	ABS4613403	ABS5613403
	0.44 N	ABS1613503	ABS4613503	ABS5613503
Simulated roller lever	0.34 N	ABS1614403	ABS4614403	ABS5614403
	0.54 N	ABS1614503	ABS4614503	ABS5614503
Roller lever	0.39 N	ABS1616403	ABS4616403	ABS5616403
	0.59 N	ABS1616503	ABS4616503	ABS5616503

Au-clad triple layer

Actuator	Operating force Max.	SPDT		
		Straight	Wire position Right angle	Left angle
Pin plunger	0.98 N	ABS1610413	ABS4610413	ABS5610413
	1.47 N	ABS1610513	ABS4610513	ABS5610513
Short hinge lever	0.39 N	ABS1611413	ABS4611413	ABS5611413
	0.59 N	ABS1611513	ABS4611513	ABS5611513
Hinge lever	0.34 N	ABS1612413	ABS4612413	ABS5612413
	0.54 N	ABS1612513	ABS4612513	ABS5612513
Long hinge lever	0.25 N	ABS1613413	ABS4613413	ABS5613413
	0.44 N	ABS1613513	ABS4613513	ABS5613513
Simulated roller lever	0.34 N	ABS1614413	ABS4614413	ABS5614413
	0.54 N	ABS1614513	ABS4614513	ABS5614513
Roller lever	0.39 N	ABS1616413	ABS4616413	ABS5616413
	0.59 N	ABS1616513	ABS4616513	ABS5616513

Au-clad double layer

Actuator	Operating force Max.	SPDT		
		Straight	Wire position Right angle	Left angle
Pin plunger	0.98 N	ABS1610449	ABS4610449	ABS5610449
	1.47 N	ABS1610549	ABS4610549	ABS5610549
Short hinge lever	0.39 N	ABS1611449	ABS4611449	ABS5611449
	0.59 N	ABS1611549	ABS4611549	ABS5611549
Hinge lever	0.34 N	ABS1612449	ABS4612449	ABS5612449
	0.54 N	ABS1612549	ABS4612549	ABS5612549
Long hinge lever	0.25 N	ABS1613449	ABS4613449	ABS5613449
	0.44 N	ABS1613549	ABS4613549	ABS5613549
Simulated roller lever	0.34 N	ABS1614449	ABS4614449	ABS5614449
	0.54 N	ABS1614549	ABS4614549	ABS5614549
Roller lever	0.39 N	ABS1616449	ABS4616449	ABS5616449
	0.59 N	ABS1616549	ABS4616549	ABS5616549

* Agency standard: Please refer to "Ordering information".

3. Immersion protected type (2 wire leads type SPST-NC)

AgNi alloy

Actuator	Operating force Max.	SPST-NC		
		Straight	Wire position Right angle	Left angle
Pin plunger	0.98 N	ABS1620403	ABS4620403	ABS5620403
	1.47 N	ABS1620503	ABS4620503	ABS5620503
Short hinge lever	0.39 N	ABS1621403	ABS4621403	ABS5621403
	0.59 N	ABS1621503	ABS4621503	ABS5621503
Hinge lever	0.34 N	ABS1622403	ABS4622403	ABS5622403
	0.54 N	ABS1622503	ABS4622503	ABS5622503
Long hinge lever	0.25 N	ABS1623403	ABS4623403	ABS5623403
	0.44 N	ABS1623503	ABS4623503	ABS5623503
Simulated roller lever	0.34 N	ABS1624403	ABS4624403	ABS5624403
	0.54 N	ABS1624503	ABS4624503	ABS5624503
Roller lever	0.39 N	ABS1626403	ABS4626403	ABS5626403
	0.59 N	ABS1626503	ABS4626503	ABS5626503

Au-clad triple layer

Actuator	Operating force Max.	SPST-NC		
		Straight	Wire position Right angle	Left angle
Pin plunger	0.98 N	ABS1620413	ABS4620413	ABS5620413
	1.47 N	ABS1620513	ABS4620513	ABS5620513
Short hinge lever	0.39 N	ABS1621413	ABS4621413	ABS5621413
	0.59 N	ABS1621513	ABS4621513	ABS5621513
Hinge lever	0.34 N	ABS1622413	ABS4622413	ABS5622413
	0.54 N	ABS1622513	ABS4622513	ABS5622513
Long hinge lever	0.25 N	ABS1623413	ABS4623413	ABS5623413
	0.44 N	ABS1623513	ABS4623513	ABS5623513
Simulated roller lever	0.34 N	ABS1624413	ABS4624413	ABS5624413
	0.54 N	ABS1624513	ABS4624513	ABS5624513
Roller lever	0.39 N	ABS1626413	ABS4626413	ABS5626413
	0.59 N	ABS1626513	ABS4626513	ABS5626513

Au-clad double layer

Actuator	Operating force Max.	SPST-NC		
		Straight	Wire position Right angle	Left angle
Pin plunger	0.98 N	ABS1620449	ABS4620449	ABS5620449
	1.47 N	ABS1620549	ABS4620549	ABS5620549
Short hinge lever	0.39 N	ABS1621449	ABS4621449	ABS5621449
	0.59 N	ABS1621549	ABS4621549	ABS5621549
Hinge lever	0.34 N	ABS1622449	ABS4622449	ABS5622449
	0.54 N	ABS1622549	ABS4622549	ABS5622549
Long hinge lever	0.25 N	ABS1623449	ABS4623449	ABS5623449
	0.44 N	ABS1623549	ABS4623549	ABS5623549
Simulated roller lever	0.34 N	ABS1624449	ABS4624449	ABS5624449
	0.54 N	ABS1624549	ABS4624549	ABS5624549
Roller lever	0.39 N	ABS1626449	ABS4626449	ABS5626449
	0.59 N	ABS1626549	ABS4626549	ABS5626549

* Agency standard: Please refer to "Ordering information".

ABS1,4,5

4. Immersion protected type (2 wire leads type SPST-NO)

AgNi alloy

Actuator	Operating force Max.	SPST-NO		
		Wire position		
		Straight	Right angle	Left angle
Pin plunger	0.98 N	ABS1630403	ABS4630403	ABS5630403
	1.47 N	ABS1630503	ABS4630503	ABS5630503
Short hinge lever	0.39 N	ABS1631403	ABS4631403	ABS5631403
	0.59 N	ABS1631503	ABS4631503	ABS5631503
Hinge lever	0.34 N	ABS1632403	ABS4632403	ABS5632403
	0.54 N	ABS1632503	ABS4632503	ABS5632503
Long hinge lever	0.25 N	ABS1633403	ABS4633403	ABS5633403
	0.44 N	ABS1633503	ABS4633503	ABS5633503
Simulated roller lever	0.34 N	ABS1634403	ABS4634403	ABS5634403
	0.54 N	ABS1634503	ABS4634503	ABS5634503
Roller lever	0.39 N	ABS1636403	ABS4636403	ABS5636403
	0.59 N	ABS1636503	ABS4636503	ABS5636503

Au-clad triple layer

Actuator	Operating force Max.	SPST-NO		
		Wire position		
		Straight	Right angle	Left angle
Pin plunger	0.98 N	ABS1630413	ABS4630413	ABS5630413
	1.47 N	ABS1630513	ABS4630513	ABS5630513
Short hinge lever	0.39 N	ABS1631413	ABS4631413	ABS5631413
	0.59 N	ABS1631513	ABS4631513	ABS5631513
Hinge lever	0.34 N	ABS1632413	ABS4632413	ABS5632413
	0.54 N	ABS1632513	ABS4632513	ABS5632513
Long hinge lever	0.25 N	ABS1633413	ABS4633413	ABS5633413
	0.44 N	ABS1633513	ABS4633513	ABS5633513
Simulated roller lever	0.34 N	ABS1634413	ABS4634413	ABS5634413
	0.54 N	ABS1634513	ABS4634513	ABS5634513
Roller lever	0.39 N	ABS1636413	ABS4636413	ABS5636413
	0.59 N	ABS1636513	ABS4636513	ABS5636513

Au-clad double layer

Actuator	Operating force Max.	SPST-NO		
		Wire position		
		Straight	Right angle	Left angle
Pin plunger	0.98 N	ABS1630449	ABS4630449	ABS5630449
	1.47 N	ABS1630549	ABS4630549	ABS5630549
Short hinge lever	0.39 N	ABS1631449	ABS4631449	ABS5631449
	0.59 N	ABS1631549	ABS4631549	ABS5631549
Hinge lever	0.34 N	ABS1632449	ABS4632449	ABS5632449
	0.54 N	ABS1632549	ABS4632549	ABS5632549
Long hinge lever	0.25 N	ABS1633449	ABS4633449	ABS5633449
	0.44 N	ABS1633549	ABS4633549	ABS5633549
Simulated roller lever	0.34 N	ABS1634449	ABS4634449	ABS5634449
	0.54 N	ABS1634549	ABS4634549	ABS5634549
Roller lever	0.39 N	ABS1636449	ABS4636449	ABS5636449
	0.59 N	ABS1636549	ABS4636549	ABS5636549

* Agency standard: Please refer to "Ordering information".

5. Immersion protected type (3 wire leads type SPDT)

- Leaf lever type
- AgNi alloy

Actuator	Operating force Max.	SPDT		
		Straight	Wire position Right angle	Left angle
Leaf lever	0.88 N	ABS1618403	ABS4618403	ABS5618403
	1.08 N	ABS1618503	ABS4618503	ABS5618503

Au-clad triple layer

Actuator	Operating force Max.	SPDT		
		Straight	Wire position Right angle	Left angle
Leaf lever	0.88 N	ABS1618413	ABS4618413	ABS5618413
	1.08 N	ABS1618513	ABS4618513	ABS5618513

Au-clad double layer

Actuator	Operating force Max.	SPDT		
		Straight	Wire position Right angle	Left angle
Leaf lever	0.88 N	ABS1618449	ABS4618449	ABS5618449
	1.08 N	ABS1618549	ABS4618549	ABS5618549

6. Immersion protected type (2 wire leads type SPST-NC)

- Leaf lever type
- AgNi alloy

Actuator	Operating force Max.	SPST-NC		
		Straight	Wire position Right angle	Left angle
Leaf lever	0.88 N	ABS1628403	ABS4628403	ABS5628403
	1.08 N	ABS1628503	ABS4628503	ABS5628503

Au-clad triple layer

Actuator	Operating force Max.	SPST-NC		
		Straight	Wire position Right angle	Left angle
Leaf lever	0.88 N	ABS1628413	ABS4628413	ABS5628413
	1.08 N	ABS1628513	ABS4628513	ABS5628513

Au-clad double layer

Actuator	Operating force Max.	SPST-NC		
		Straight	Wire position Right angle	Left angle
Leaf lever	0.88 N	ABS1628449	ABS4628449	ABS5628449
	1.08 N	ABS1628549	ABS4628549	ABS5628549

7. Immersion protected type (2 wire leads type SPST-NO)

- Leaf lever type
- AgNi alloy

Actuator	Operating force Max.	SPST-NO		
		Straight	Wire position Right angle	Left angle
Leaf lever	0.88 N	ABS1638403	ABS4638403	ABS5638403
	1.08 N	ABS1638503	ABS4638503	ABS5638503

Au-clad triple layer

Actuator	Operating force Max.	SPST-NO		
		Straight	Wire position Right angle	Left angle
Leaf lever	0.88 N	ABS1638413	ABS4638413	ABS5638413
	1.08 N	ABS1638513	ABS4638513	ABS5638513

* Agency standard: Please refer to "Ordering information".

ABS1,4,5

Au-clad double layer

Actuator	Operating force Max. gf	SPST-NO		
		Straight	Wire position Right angle	Left angle
Leaf lever	0.89 N	ABS1638449	ABS4638449	ABS5638449
	1.08 N	ABS1638549	ABS4638549	ABS5638549

* Agency standard: Please refer to "Ordering information".

SPECIFICATIONS

1. Contact rating

Voltage	AgNi alloy contact type		Au-clad contact type	
			Au-clad triple layer	Au-clad twin layer
	Resistive load	Inductive load	Resistive load	
125 V AC	2 A	2 A	0.1 A	—
250 V AC	2 A	2 A	0.1 A	—
30 V DC	2 A	2 A	0.1 A	0.1 A
125 V DC	0.4 A	0.05 A	—	—

Low-level circuit rating (Au-clad contact type)

Rated voltage	Resistive load
6 V DC	5 mA
12 V DC	2 mA
24 V DC	1 mA

Recommended contact material chart classified by load voltage & current (reference)

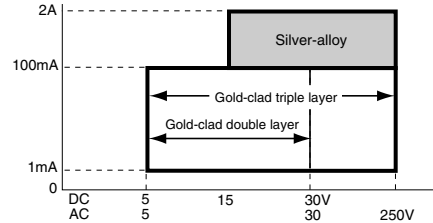

Remarks: If the contact is being used in the constant low-level circuit load range, the Au-clad twin layer contact is recommended. If there is a danger of the current being less than 0.5 A, for instance if the contact is being turned on and off, the Au-clad triple layer type is recommended.

2. Characteristics

Mechanical life (O.T.: Specified value)	Leaf lever	Min. 5x10 ⁵ (at 60 cpm)
	Other types	Min. 5x10 ⁶ (at 60 cpm)
Electrical life at rated load (O.T.: Max.)	AgNi alloy contact type	Min. 5x10 ⁴ (at 20 cpm)
	Au-clad contact type	Min. 2x10 ⁵ (at 20 cpm)
Insulation resistance	Min. 100 MΩ (at 500 V DC insulation resistance meter)	
Dielectric strength	1,000 Vrms	
Between non-continuous terminals	1,500 Vrms	
Between each terminal and other exposed metal parts	1,500 Vrms	
Between each terminal and ground	1,500 Vrms	
Vibration resistance (Pin plunger type)	10 to 55 Hz at single amplitude of 0.75 mm (Contact opening Max. 1 msec.)	
Shock resistance (Pin plunger type)	Min. 294 m/s ² (Contact opening Max. 1 msec.)	
Contact resistance (Initial)	AgNi alloy contact type	Dust protected type (IP50): Max. 50 mΩ Immersion protected type (IP67): Max. 100 mΩ (By voltage drop 1 A 6 to 8 V DC)
	Au-clad contact type	Dust protected type (IP50): Max. 100 mΩ Immersion protected type (IP67): Max. 150 mΩ (By voltage drop 0.1 A 6 to 8 V DC)
Allowable operating speed (at no load)	0.1 to 500 mm/sec.	
Max. operating cycle rate (at no load)	120 cpm	
Ambient temperature	-40°C to +85°C	
Unit weight	Approx. 2 g (IP50 type)	

3. Operating characteristics

Type of actuator	Operating force, Max.		Release force, Min.		Pretravel, Max. mm	Movement differential, Max. mm	Overtravel, Min. mm	Operating position, mm
	0.98N	1.47N	0.15N	0.20N				
Pin plunger	0.39N	0.59N	0.034N	0.039N	0.6	0.1	0.4	8.4±0.3
Short hinge lever	0.34N	0.54N	0.029N	0.034N	2.5	0.5	0.8	8.8±0.8
Hinge lever	0.25N	0.44N	0.025N	0.029N	2.8	0.8	1.2	8.8±0.8
Long hinge lever	0.34N	0.54N	0.029N	0.034N	3.5	1.0	1.6	8.8±1.2
Simulated roller lever	0.39N	0.59N	0.034N	0.039N	2.8	0.8	1.2	11.65±0.8
Roller lever	0.88N	1.08N	0.17N	0.20N	2.5	0.5	0.8	14.5±0.8
Leaf lever	0.88N	1.08N	0.17N	0.20N	4.5	1.0	2.5	14.5±1.5

ABS1,4,5

Simulated roller lever

mm General tolerance: ± 0.25

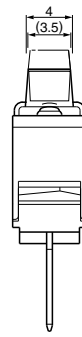
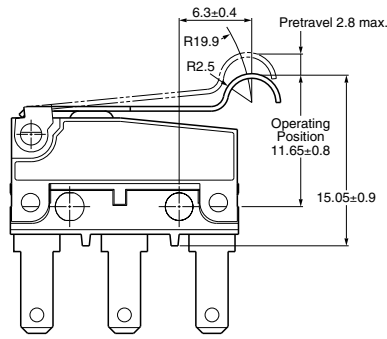
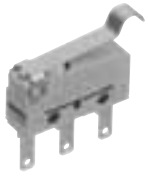

Pretravel, Max. mm	2.8	
Movement differential, Max. mm	0.8	
Overtravel, Min. mm	1.2	
Operating position	Distance from mounting hole, mm	11.65±0.8
	Distance from stand-off, mm	15.05±0.9

Roller lever

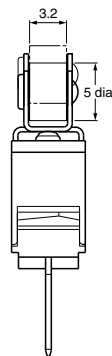
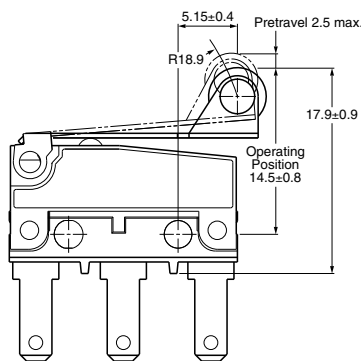
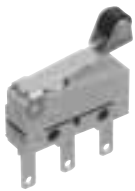

Pretravel, Max. mm	2.5	
Movement differential, Max. mm	0.5	
Overtravel, Min. mm	0.8	
Operating position	Distance from mounting hole, mm	14.5±0.8
	Distance from stand-off, mm	17.9±0.9

1-(2) Solder terminal

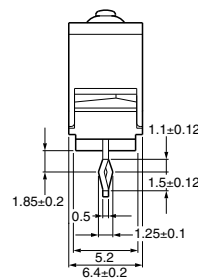
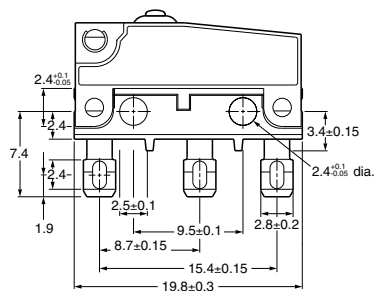
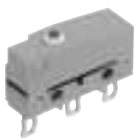

Remarks: Dimensions of the actuator types are the same as those of corresponding .110 quick-connect terminal types.

1-(3) PC board terminal Straight type

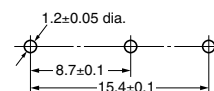
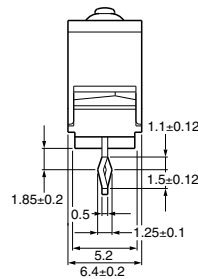
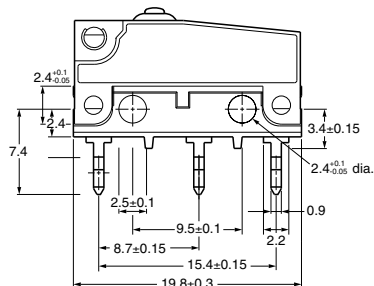
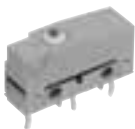

Remarks: Dimensions of the actuator types are the same as those of corresponding .110 quick-connect terminal types.

Right angle type

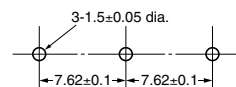
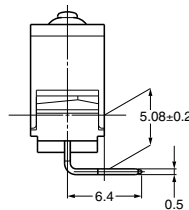
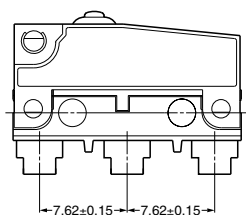
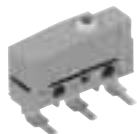

Remarks: Dimensions of the actuator types are the same as those of corresponding .110 quick-connect terminal types.

Left angle type

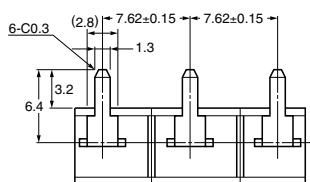
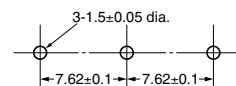
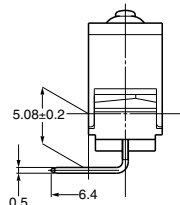
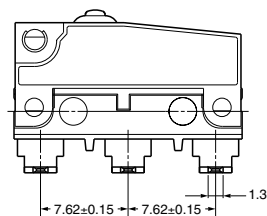

Remarks: Dimensions of the actuator types are the same as those of corresponding .110 quick-connect terminal types.

2. Immersion protected type

Wire leads
Pin plunger
Straight type

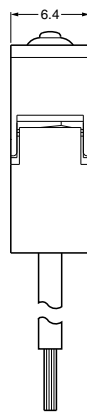
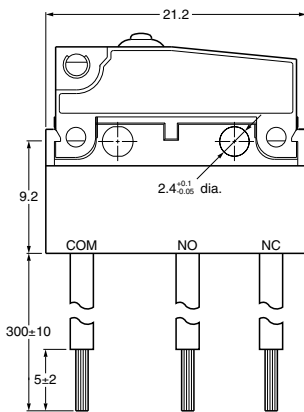

Thickness of the lead wire: 0.5 mm²
UL/CSA approved type and Right/Left angle type:
AWG #20
Color of the lead wire:
COM ... Black
N.C. ... Red
N.O. ... White

Remarks: 1. Other dimensions are the same as those of .110 quick-connect terminal types.
2. Dimensions of the actuator types are the same as those of corresponding .110 quick-connect terminal types.

Right angle type

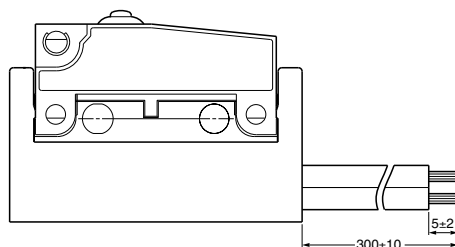

Left angle type

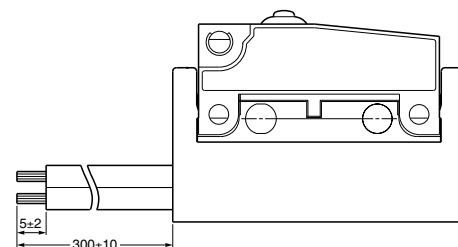

ABS1,4,5

Leaf lever
Straight type

mm General tolerance: ± 0.25

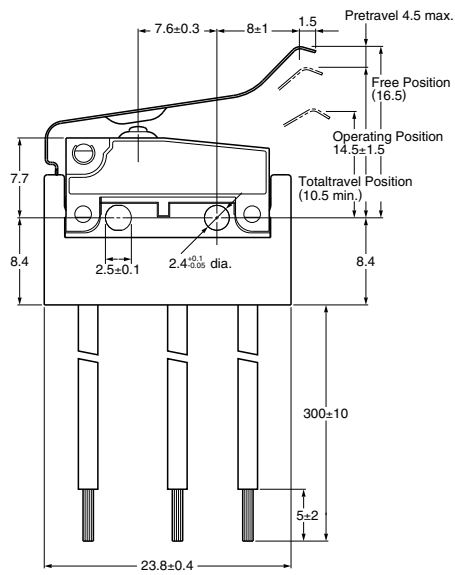
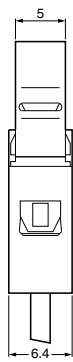
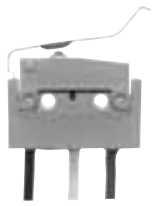

Thickness of the lead wire: 0.5 mm²
 UL/CSA approved type and Right/Left angle type:
 AWG #20
 Color of the lead wire:
 COM... Black
 N.C. ... Red
 N.O. ... White

Right angle type

Left angle type

